

MR16 LED LIGHTING ASSEMBLY
FOR CONCEPT 3 AND FRACTIONAL SERIES AERATORS

STEP 1 – MOUNTING THE JUNCTION BOX ASSEMBLY TO AERATOR

A) USE 7/16" NUT DRIVER AND REMOVE 1/4-20 LOCK NUT TO OPEN BAND CLAMP

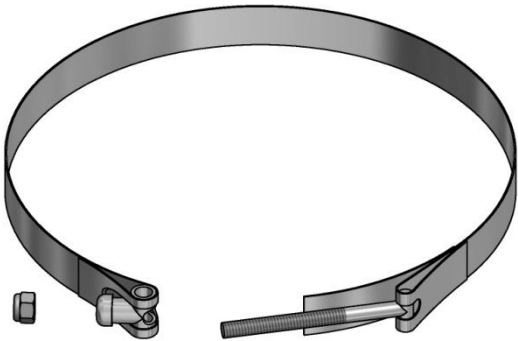

USE PART 46-0066 (5-1/2" T-BOLT BAND CLAMP)
FOR THE FRACTIONAL SERIES AERATORS

USE PART 46-0129 (8" T-BOLT BAND CLAMP)
FOR THE CONCEPT 3 SERIES AERATORS

B)

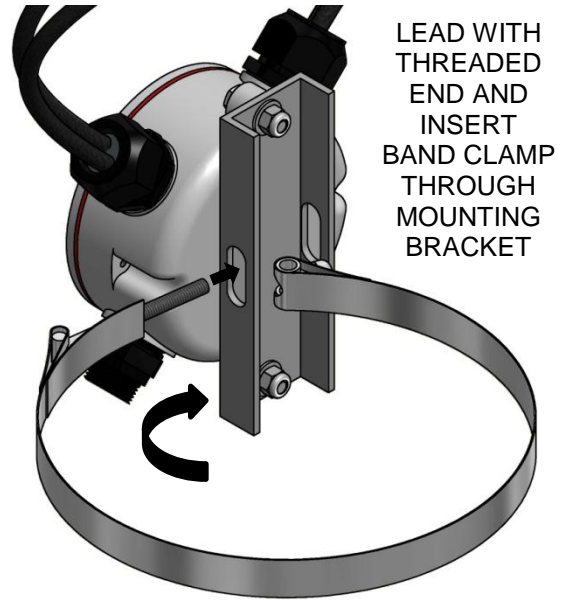

C)

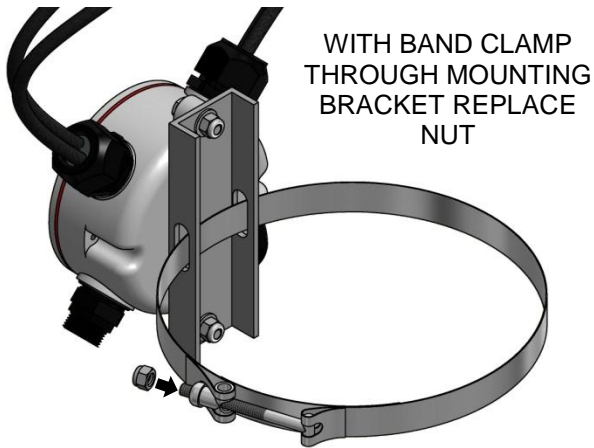

D)

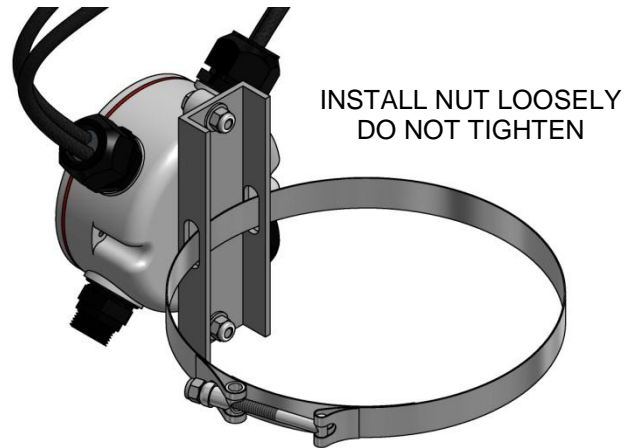

E)

SLIDE J-BOX/BAND CLAMP ASSEMBLY
ONTO AERATOR HOUSING



F)

TIGHTEN BAND CLAMP WITH 7/16" NUT DRIVER
(TO PREVENT DAMAGE DO NOT OVER-TIGHTEN)
CONNECT POWER CABLE BEFORE LAUNCHING

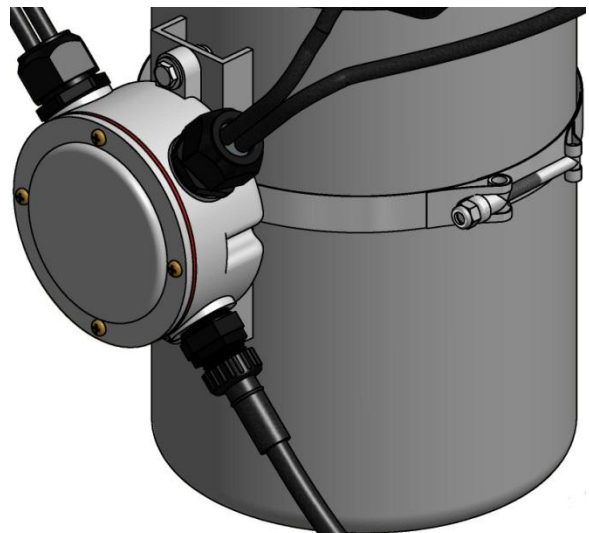

STEP 2 – MOUNTING THE MR16 LED LIGHTS TO AERATOR

MOUNTING TO CONCEPT 3 AERATOR

A) LIGHT HOUSINGS MAY BE MOUNTED WITH BRACKET UP OR DOWN AS SHOWN TO GIVE THE DESIRED LIGHTING AND APPEARANCE



B) USE 7/16" WRENCHES TO FASTEN BRACKETS TO CONCEPT 3 FLOAT



ADJUST HOUSING ANGLE TO MAXIMIZE PATTERN ILLUMINATION

Concept 3 Mounting Hardware Parts List			
ITEM	QTY	PART NUMBER	DESCRIPTION
1	1	40-0100	Light Housing Mounting Bracket
2	1	24-0017	1/4-20 x 5/8" Hex Bolt
3	2	28-0013	1/4" Star Washer
4	1	927-000	1/4" Flat Washer
5	1	24-0016	1/4-20 x 1-1/2" Hex Bolt
6	1	28-0001	1/4" Fender Washer
7	1	C2-112	1/4-20 Nylon Lock Nut

IMPORTANT NOTE
FOR ALL UNITS REMOVE CABLE SLACK USING THE NYLON WIRE TIES SUPPLIED WITH EACH MR16 LED LIGHTING KIT BY FASTENING CABLES TO THE AERATOR UNIT

MOUNTING TO FRACTIONAL SERIES UNIT

A) MR16 LED FIXTURES SNAP INTO SLOTS (2 PLACES) ON THE FRACTIONAL SERIES FLOAT



MOUNTING THE JUNCTION BOX TO THE GIANT FOUNTAIN

- A) USE 7/16" NUT DRIVER AND REMOVE 1/4-20 LOCK NUT TO OPEN BAND CLAMP

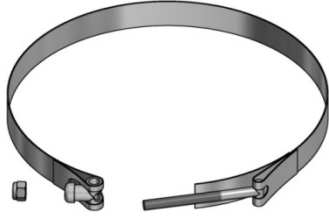

USE PART 46-0067 (4-1/2" T-BOLT BAND CLAMP) FOR THE GIANT FOUNTAIN

- C) WITH BAND CLAMP OPEN POSITION JUNCTION BOX ON THE UPPER FLOW SLEEVE, REPLACE BAND CLAMP NUT AND TIGHTEN WITH 7/16" NUT DRIVER

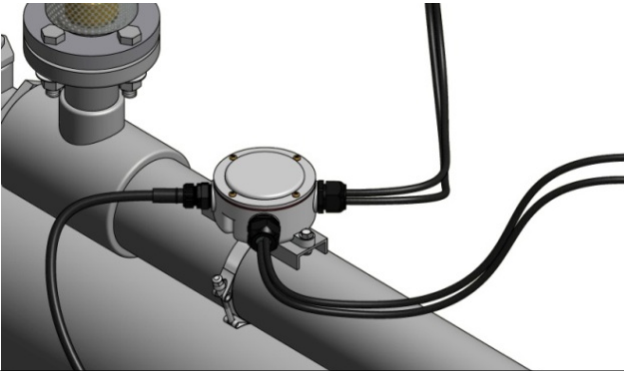

IMPORTANT
FOR ALL UNITS REMOVE CABLE SLACK USING THE NYLON WIRE TIES SUPPLIED WITH EACH MR16 LED LIGHTING KIT BY FASTENING CABLES TO THE AERATOR UNIT

- B)



LEAD WITH THREADED END AND INSERT BAND CLAMP THROUGH MOUNTING BRACKET

MOUNTING THE MR16 LED LIGHTS TO AERATOR

- A) INSTALLING OUTSIDE MOUNTING BRACKETS



- B) INSTALLING INSIDE MOUNTING BRACKETS

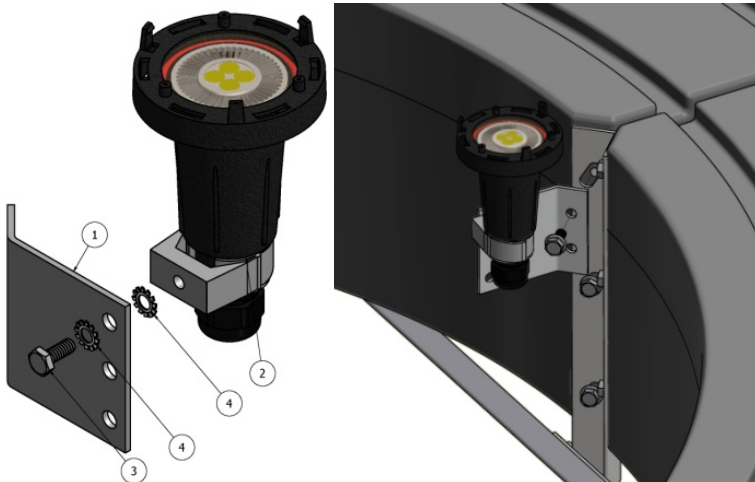

REMOVE TOP INSIDE FLOAT CONNECTOR BOLT. FASTEN BRACKET WITH THIS BOLTS

Parts List			
ITEM	QTY	PART NUMBER	DESCRIPTION
1	1	40-0050	Giant Fountain Inside Lighting Bracket
2	1	09-0026	MR16 LED Light Housing Assembly
3	1	24-0017	Hex Bolt 1/4-20 x 5/8"
4	2	28-0013	Star Washer 1/4"

Parts List			
ITEM	QTY	PART NUMBER	DESCRIPTION
1	1	40-0060	Giant Fountain Outside Lighting Bracket
2	2	40-0108	Giant Fountain MR16 Mounting Bracket
3	2	09-0026	MR16 LED Light Housing Assembly
4	1	MP2008	Hex Bolt 5/16-18 x 1"
5	1	28-0006	Star Washer 5/16"
6	1	GP1208	Nylon Lock Nut 5/16"
7	1	24-0017	Hex Bolt 1/4-20 x 5/8"
8	2	28-0013	Star Washer 1/4"

REMOVE TOP TWO (2) OUTSIDE FLOAT CONNECTOR BOLTS. FASTEN BRACKET USING THESE BOLTS

